

Features

- Wide Operating Voltage Range: 3.3V~45V
- Low Quiescent Current : 2.0mA
- Device HBM ESD Classification Level Class3B
- Reverse Supply Protection
- 40mA Load Capacity
- TO92S-3 package
- Magnetic Field Operate Point : 135Gs
- Magnetic Field Release Point : 65Gs

Applications

- Docking detection and proximity sensing
- Door and window sensors
- Valve positioning
- Pulse counting

General Description

The XL557 is an unipolar Hall switch sensor that optimized for wide voltage, low quiescent current and wide temperature range. XL557 supports a power supply voltage of up to 50V and provide a load capacity of up to 40mA. Widely used in automotive electronics, industrial control and other applications. Adopting a collector open circuit output architecture, it has strong resistance to electromagnetic interference.

The XL557 integrates a reference voltage source, temperature compensation, Hall array, differential comparator, hysteresis latch, and power output stage, providing high magnetic field consistency, and strong immunity to electromagnetic interference over the full voltage range and full temperature range.

Typical application schematic

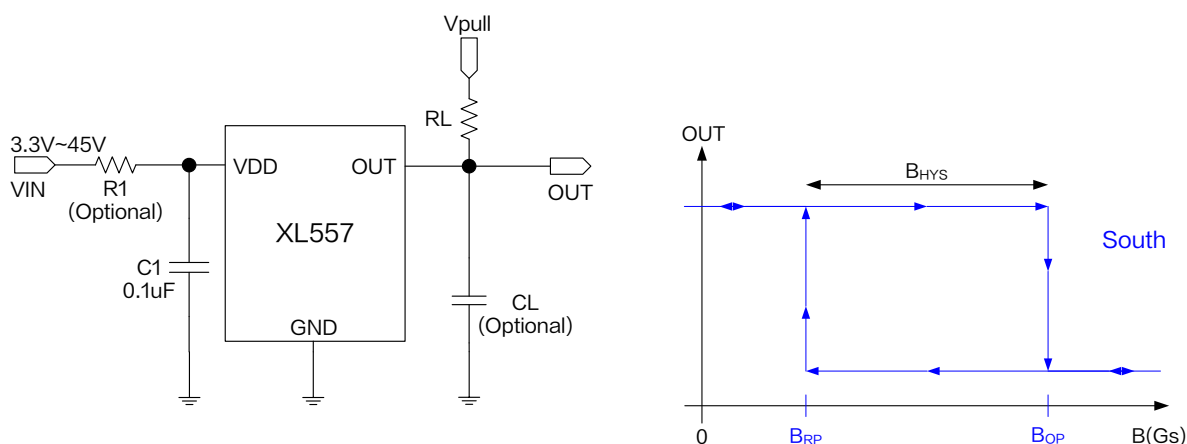

Figure1. XL557 Typical application schematic and output characteristic curve

Unipolar Hall Switch Sensor

XL557

Pin Configurations

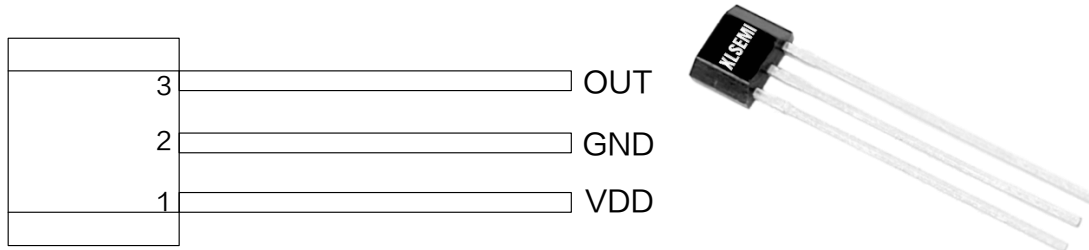

Figure2. Pin Configuration of XL557

Table 1 Pin Description

Pin Number	Pin Name	Description
1	VDD	Supply Voltage Input Pin. XL557 operates from 3.3V to 45V DC voltage.
2	GND	Ground pin.
3	OUT	Open Collector Output Pin, requires a resistor pull-up.

Ordering Information

Order Information	Marking ID	Package Type	Eco Plan	Packing Type Supplied As
XL557	XL557	TO92S-3	RoHS & HF	1000 Units Per Bag

Function Block

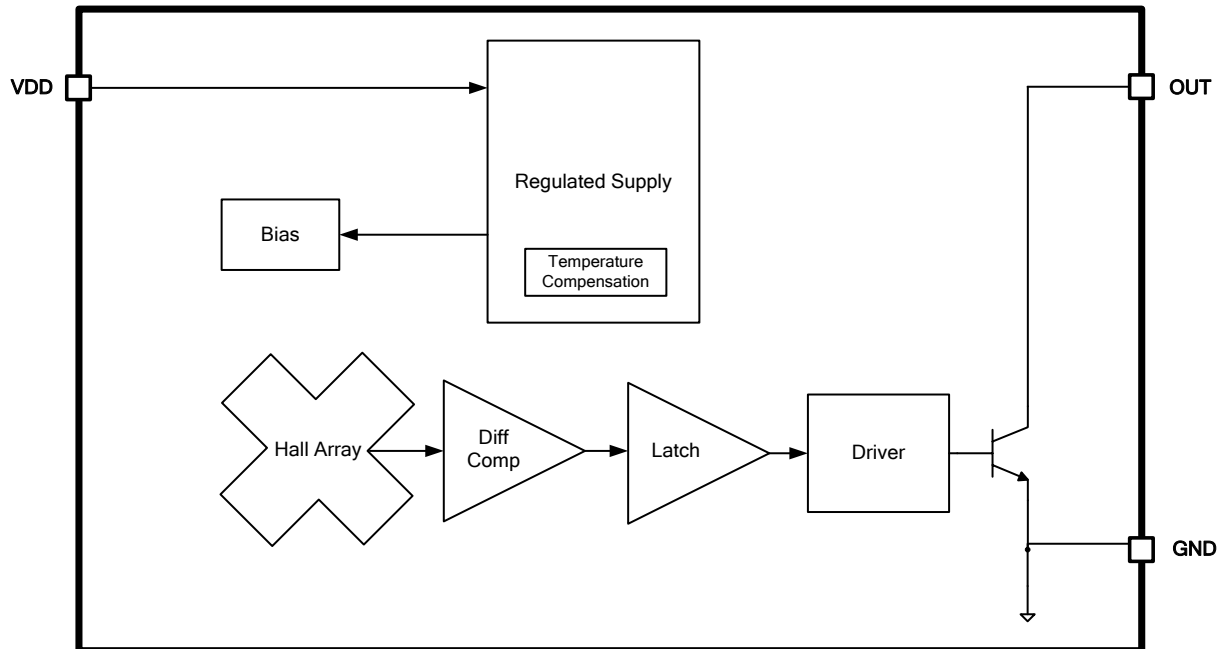

Figure3. Function Block Diagram of XL557

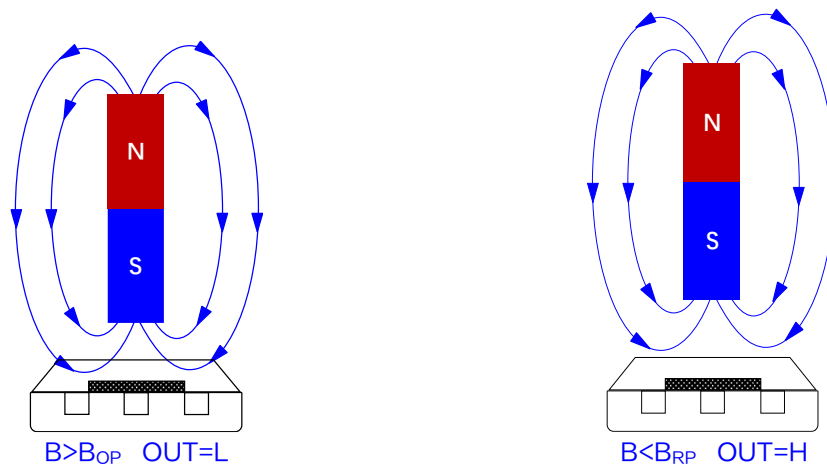

Figure4. Magnetic Field Direction Definition

Unipolar Hall Switch Sensor

XL557

Absolute Maximum Ratings (Note1)

Parameter	Symbol	Value	Unit
Input Voltage	V_{DD}	-50 ~ 50	V
Output Pin Voltage	V_{OUT}	-0.5 ~ 50	V
Output Pin Current Sink	I_{SINK}	0 ~ 40	mA
Thermal Resistance (TO92S-3) (Junction to Ambient, No Heatsink, Free Air)	R_{JA}	160	°C/W
Operating Temperature	T_A	-40 ~ 125	°C
Operating Junction Temperature	T_J	-40 ~ 150	°C
Storage Temperature	T_{STG}	-65 ~ 150	°C
Lead Temperature (Soldering, 10 sec)	T_{LEAD}	260	°C
ESD (HBM)		>8000	V

Note1: Stresses greater than those listed under Maximum Ratings may cause permanent damage to the device. This is a stress rating only and functional operation of the device at these or any other conditions above those indicated in the operation is not implied. Exposure to absolute maximum rating conditions for extended periods may affect reliability.

Unipolar Hall Switch Sensor

XL557

XL557 Electrical Characteristics

$T_A = 25^\circ\text{C}$, $V_{DD} = V_{pull} = 5\text{V}$, $R_L = 1\text{k}\Omega$, $R_1 = 0\Omega$; system parameters test circuit figure1, unless otherwise specified.

Parameters	Symbol	Test Condition	Min.	Typ.	Max.	Unit
Operation Voltage	V_{DD}		3.3		45	V
Reverse Supply Voltage	V_{DDR}		-45			V
Operation Supply Current	I_{DD_H}	OUT=H		2.0		mA
	I_{DD_L}	OUT=L		2.5		mA
Power-on time	t_{ON}			35	50	μs
Output Saturation Voltage	V_{sat}	$I_{OUT} = 30\text{mA}$		0.2	0.3	V
Output Delay Time	t_d	$B = B_{RP}$ to B_{OP}		10	25	μs
Output Rise Time	t_r	$CL = 50\text{pF}$			0.5	μs
Output Fall Time	t_f	$CL = 50\text{pF}$			0.2	μs

XL557 Magnetic Characteristics (Note2)

$T_A = 25^\circ\text{C}$, $V_{DD} = V_{pull} = 5\text{V}$, $R_L = 1\text{k}\Omega$, $R_1 = 0\Omega$; system parameters test circuit figure1, unless otherwise specified.

Parameters	Symbol	Test Condition	Min.	Typ.	Max.	Unit
Bandwidth	f_{BW}				100	KHz
Magnetic Field Operate Point	B_{OP}		100	135	170	Gs
Magnetic Field Release Point	B_{RP}		35	65	95	Gs
Magnetic Hysteresis	B_{HYS}			70		Gs

Note2 : A south pole near the marked side of the package is a positive magnetic field.

Typical Characteristics

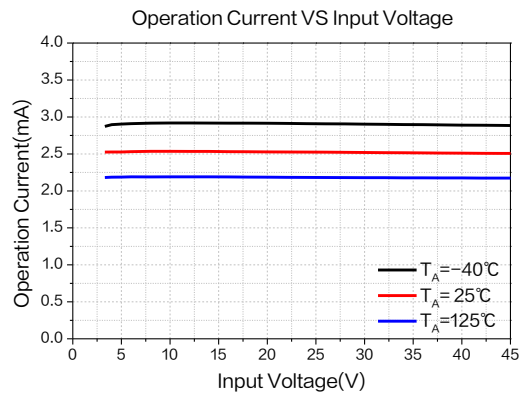

Figure 5. Operation Current

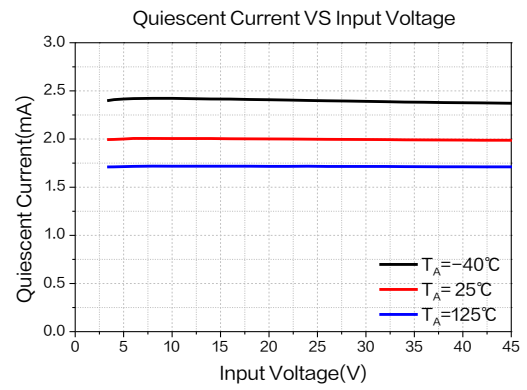
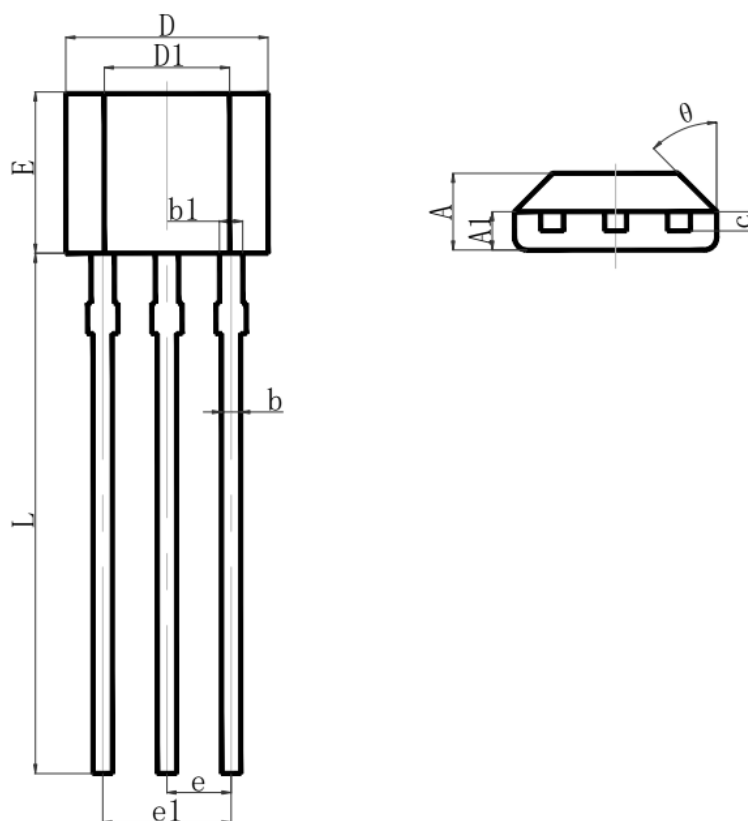

Figure 6. Quiescent Current

Package Information

TO92S-3



Symbol	Dimensions In Millimeters		Dimensions In Inches	
	Min.	Max.	Min.	Max.
A	1.42	1.62	0.056	0.064
A1	0.66	0.87	0.026	0.034
b	0.33	0.56	0.013	0.022
b1	0.40	0.51	0.016	0.020
c	0.33	0.51	0.013	0.020
D	3.90	4.10	0.154	0.161
D1	2.28	2.68	0.090	0.106
E	2.90	3.25	0.114	0.128
e	1.27 REF.		0.050 REF.	
e1	2.44	2.64	0.096	0.104
L	13.50	15.50	0.531	0.610
θ	45° REF.		45° REF.	

Unipolar Hall Switch Sensor	XL557
-----------------------------	-------

Important Notice

XLSEMI reserve the right to make modifications, enhancements, improvements, corrections or other changes without notice at any time. XLSEMI does not assume any liability arising out of the application or use of any product described herein; neither does it convey any license under its patent rights, nor the rights of others. XLSEMI assumes no liability for applications assistance or the design of Buyers' products. Buyers are responsible for their products and applications using XLSEMI components. To minimize the risks associated with Buyers' products and applications, Buyers should provide adequate design and operating safeguards. XLSEMI warrants performance of its products to the specifications applicable at the time of sale, in accordance with the warranty in XLSEMI's terms and conditions of sale of semiconductor products. Testing and other quality control techniques are used to the extent XLSEMI deems necessary to support this warranty. Except where mandated by applicable law, testing of all parameters of each component is not necessarily performed.

For the latest product information, go to www.xlsemi.com.